

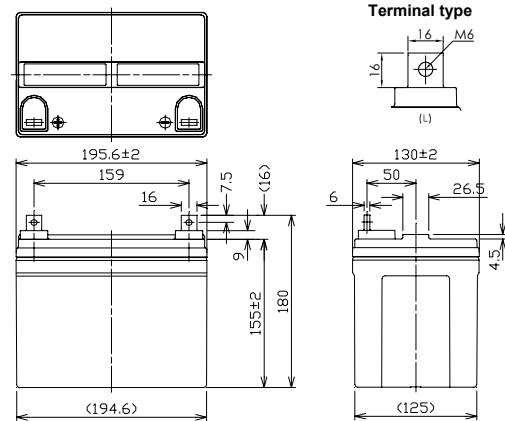

※Contents indicated (including the recycle marking, etc) are subject to change without notice.

■Dimensions(mm)



Battery case resin: standard (UL94HB)

■Specifications

Nominal Voltage		12V
Rated Capacity(20HR)		33Ah
Dimensions	Length	195.6 mm
	Width	130 mm
	Height	155 mm
	Total height	180 mm
Approx. Mass		11.5 kg
Terminal		M6 threaded post

■Characteristics

Capacity (25 °C)	20 hour rate	33Ah
	10 hour rate	31Ah
	3 hour rate	26Ah
	1 hour rate	21Ah
Internal Resistance (25 °C)	Fully charged battery	7 mΩ
Temperature Dependency of Capacity (20 hour rate)	40 °C	102%
	25 °C	100%
	0 °C	85%
	-15 °C	65%
Self Discharge (25 °C)	After 3 months	91%
	After 6 months	82%
	After 12 months	64%

■Duration of discharge vs. discharge current

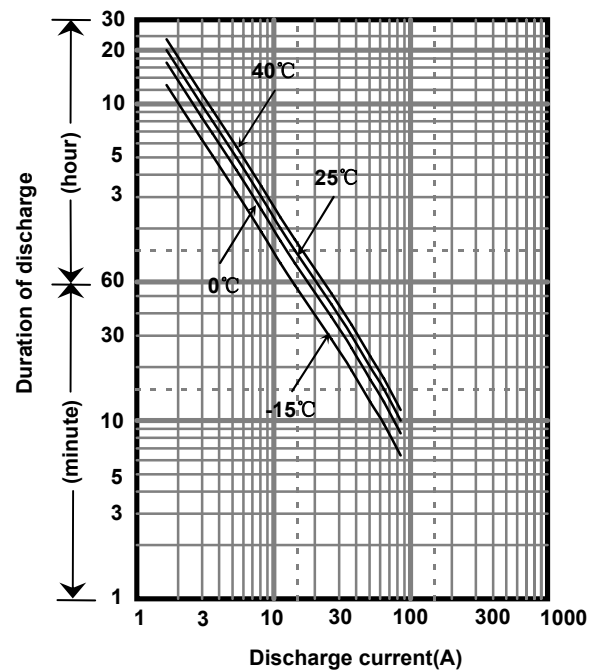

■Watt Table(25°C)

Cut-off V	(Wattage/Battery)														
	5min	10min	15min	20min	30min	45min	1h	1.5h	2h	3h	4h	5h	6h	10h	20h
9.6V	1254	948	732	635	457	328	268	187	149	107	86.6	69.5	60.5	36.9	19.8
9.9V	1182	928	721	630	452	322	262	182	148	106	85.4	68.3	60.1	36.9	19.8
10.2V	1115	899	706	619	443	321	259	170	147	105	84.2	67.7	59.7	36.9	19.8
10.5V	1051	868	684	603	433	314	256	168	146	104	83.6	67.4	59.2	36.9	19.8
10.8V	1001	823	663	590	421	281	233	162	137	99.4	82.5	67.1	58.8	36.9	19.8

■Ampere Table(25°C)

Cut-off V	(Ampere/Battery)														
	5min	10min	15min	20min	30min	45min	1h	1.5h	2h	3h	4h	5h	6h	10h	20h
9.6V	113	84.6	63.7	54.8	39.1	27.9	22.8	15.8	12.6	9.00	7.25	5.80	5.10	3.10	1.65
9.9V	106	82.9	62.7	54.4	38.6	27.4	22.2	15.5	12.5	8.85	7.15	5.70	5.05	3.10	1.65
10.2V	100	80.3	61.4	53.4	37.9	27.1	22.0	14.4	12.4	8.75	7.05	5.65	5.00	3.10	1.65
10.5V	94.3	77.5	59.5	52.0	37.0	26.8	21.8	14.3	12.3	8.70	6.98	5.63	4.95	3.10	1.65
10.8V	89.8	73.5	57.7	50.9	36.0	24.0	19.8	13.7	11.6	8.35	6.90	5.60	4.90	3.10	1.65

All mentioned values are average values

Charging Method (25°C)

Cycle use	Control voltage: 14.5-14.9V Initial current: 13.2A or smaller
-----------	--

Cut off voltage

Discharge current	1.65A-6.60A	6.60A-16.5A	16.5A-33.0A	33.0A-66.0A	66.0A-99.0A
Cut off voltage(V)	10.5	10.2	9.9	9.3	8.7

Cycle life vs. Depth of discharge

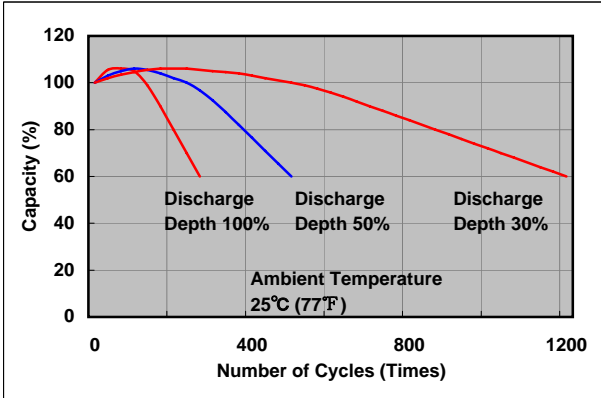

Residual capacity test result

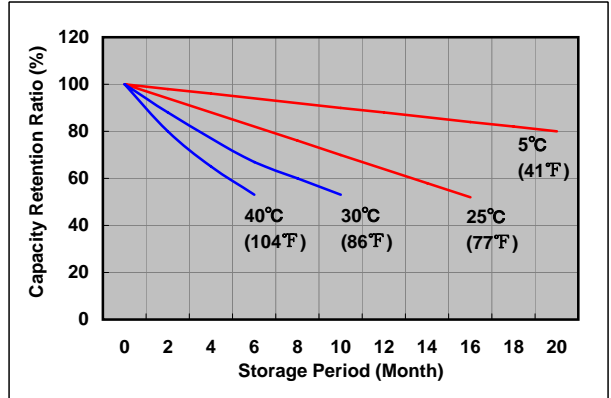

Constant-voltage constant-current charge characteristics for Cycle use

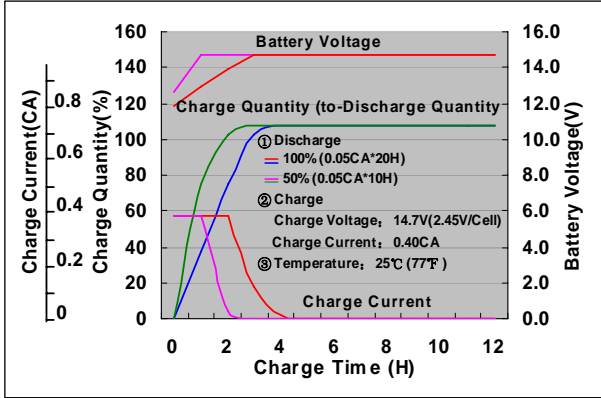

Discharge capacity by temperature and by discharge current

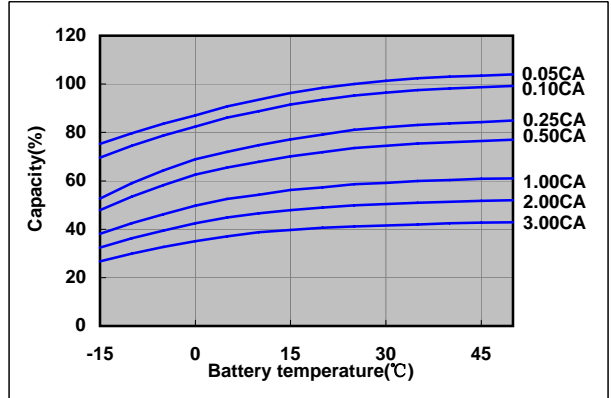

Discharge characteristics(25°C)

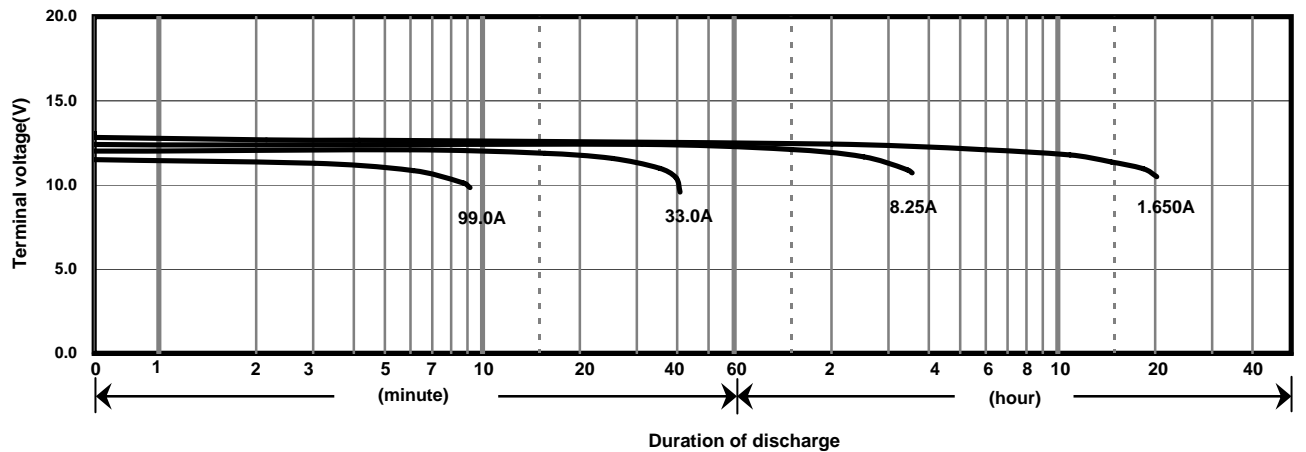

Caution
 Due to the potential energy stored in the batteries, Please read 《Precautions for handling the Rechargeable Valve Regulated Lead Acid Batteries》 before using batteries. If improper handling or use of the batteries without understanding 《Precautions for handling the Rechargeable Valve Regulated Lead Acid Batteries》 may result in bodily injury caused by electrolyte leakage, heat generation, or explosion.

Panasonic Storage Battery (Shenyang) Co., Ltd

NO. 51 Kunminghu Street, Shenyang Economic & Technical Development Zone, 110141 China
 Tel: 86 24 25818921
 Fax: 86 24 62786318
 Website: <http://www.panasonicbattery.cn>

2010.11