



HC 1228W

12V 28W

HC 1228W is specially designed for high efficient discharge application. Its invisible terminals can be inserted PC board directly. HC series battery can serve more than 260 cycles at 100% discharge in cycle service, up to 5 years in standby service.



Specification

Cells Per Unit	6
Voltage Per Unit	12
Capacity	28W @ 15min-rate to 1.67V per cell @25 °C (77°F) 7Ah @ 20hr-rate to 1.75V per cell @25°C(77°F)
Weight	Approx. 2.51 kg(5.53 lbs)
Maximum Discharge Current	60A(5sec)
Internal Resistance	Approx. 21mΩ
Operating Temperature Range	Discharge: -15°C~50°C (5°F~122°F) Charge: -15 °C~40°C (5°F~104°F) Storage: -15°C~40°C (5°F~104°F)
Nominal Operating Temperature Range	25°C±3°C(77°F±5°F)
Float Charging Voltage	13.5 to 13.8 VDC/unit Average at 25°C(77°F)
Recommended Maximum Charging Current Limit	2.8A
Equalization and Cycle Service	14.4 to 15.0 VDC/unit Average at 25°C(77°F)
Self Discharge	CSB Batteries can be stored for more than 6 months at 25°C(77°F). Please charge batteries before using. For higher temperatures the time interval will be shorter.
Terminal	C1-Faston Tab187/250
Container Material	ABS(UL 94-HB/File E50263)*Flammability resistance of (UL 94-V0/File E88637) can be available upon request.



CSB-manufactured batteries are UL-recognized components under UL924 as well as certified by ISO 9001 and ISO 14001.

Dimensions

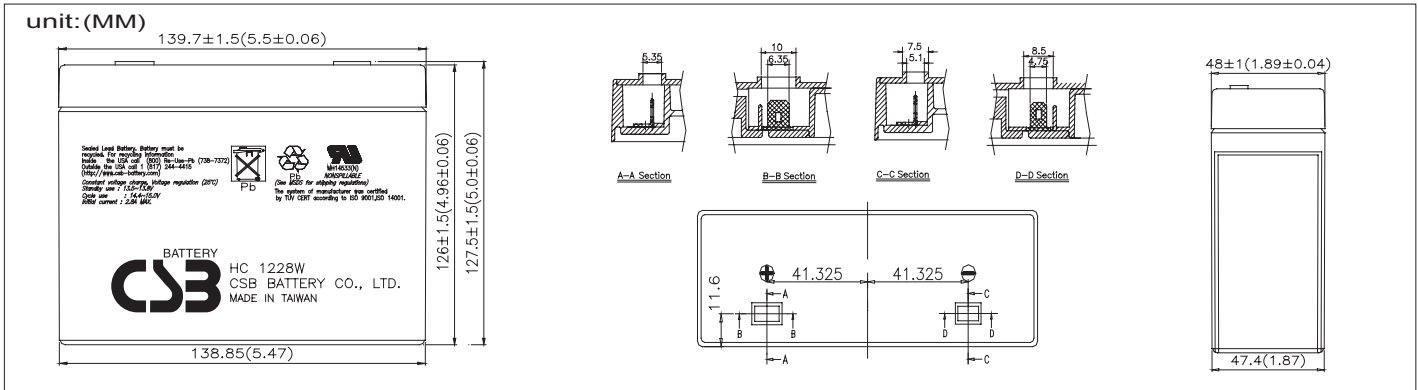

Constant Current Discharge Characteristics Unit:A (25°C,77°F)

F.V/Time	2MIN	4MIN	6MIN	8MIN	10MIN	15MIN	20MIN	30MIN	60MIN	90MIN
1.60V	48.6	38.2	31.3	27.2	23.3	18.0	14.9	11.6	7.33	4.75
1.67V	46.9	36.8	30.2	26.3	22.7	17.5	14.7	11.5	7.26	4.59
1.70V	45.2	35.4	29.3	25.5	22.1	17.0	14.4	11.4	7.19	4.43
1.75V	43.4	34.0	28.2	24.5	21.4	16.6	14.2	11.3	7.12	4.29
1.80V	41.4	32.6	27.1	23.6	20.8	16.3	14.0	11.2	7.03	4.14
1.85V	39.4	30.9	26.0	22.7	20.1	16.0	13.8	11.1	6.92	4.00

Constant Power Discharge Characteristics Unit:W (25°C,77°F)

F.V/Time	2MIN	4MIN	6MIN	8MIN	10MIN	15MIN	20MIN	30MIN	60MIN	90MIN
1.60V	583	458	375	326	280	212	175	139	89.5	57.0
1.67V	563	442	361	315	273	207	173	138	88.6	55.1
1.70V	544	425	349	304	265	202	170	137	87.7	53.2
1.75V	522	408	337	293	258	197	167	135	86.8	51.5
1.80V	498	391	325	280	248	193	164	134	86.0	49.7
1.85V	473	371	312	268	239	187	161	133	85.1	48.0

• All mentioned values are average values.

HC 1228W 12V 28W



Trickle (or Float) Service Life

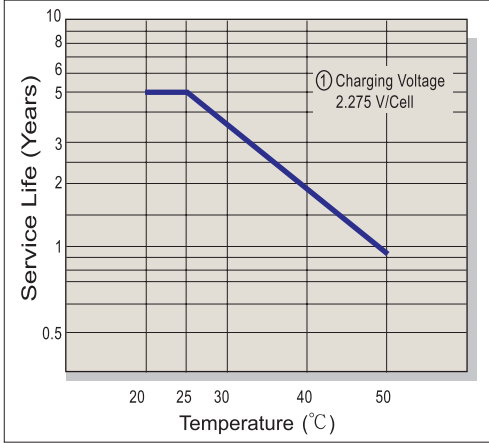

Capacity Retention Characteristic

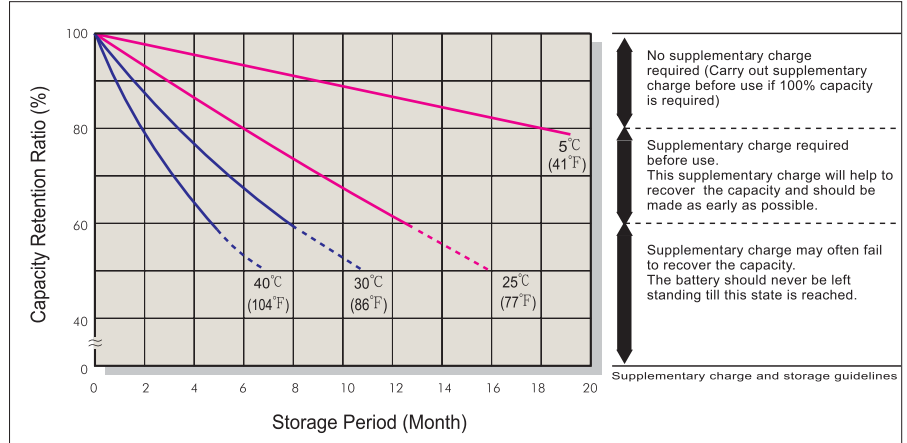

Battery Voltage and Charge Time for Standby Use

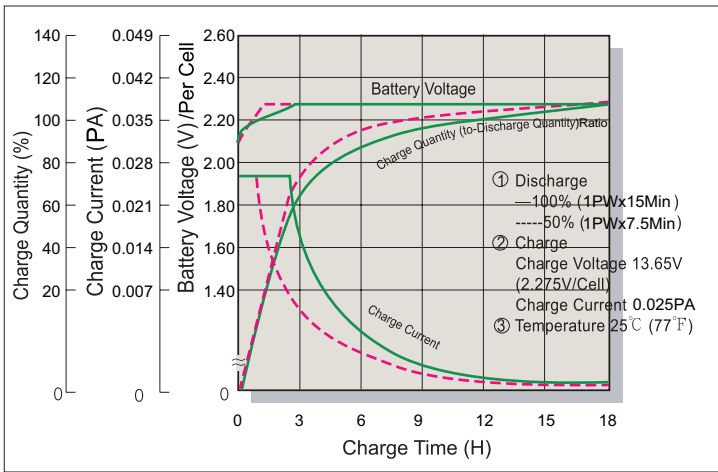

Cycle Service Life

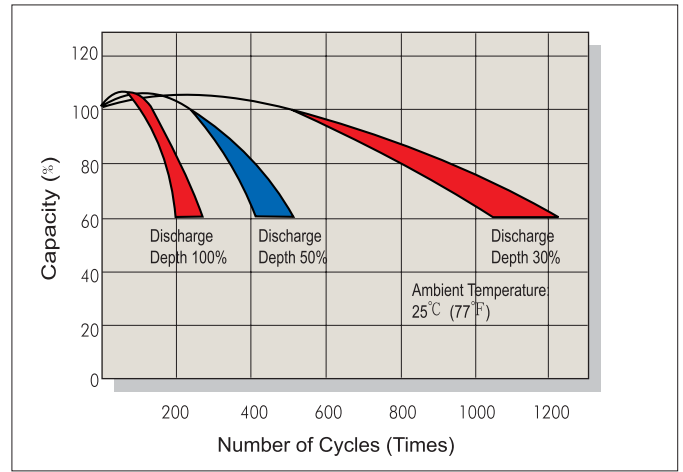

Battery Voltage and Charge Time for Cycle Use

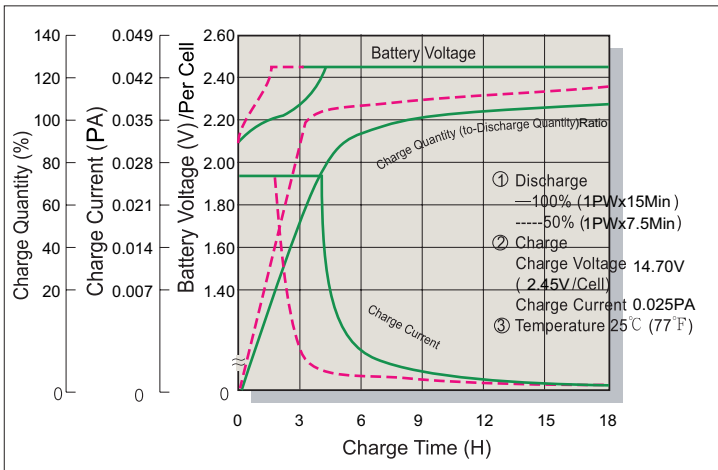

Terminal Voltage (V) and Discharge Time

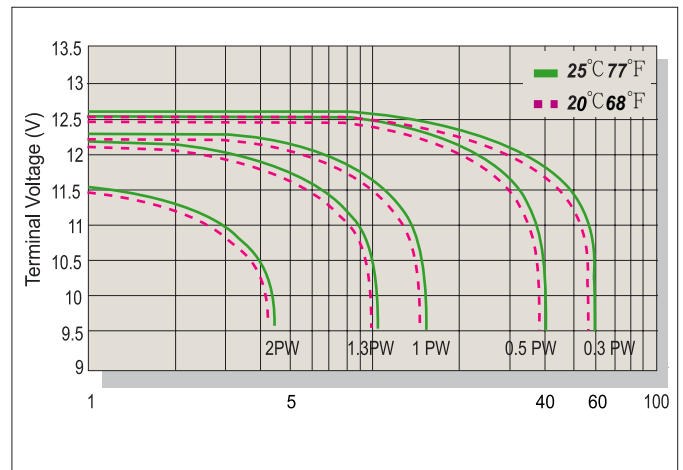

Charging Procedures

Application	Charge Voltage(V/Cell)			Max.Charge Current
	Temperature	Set Point	Allowable Range	
Cycle Use	25°C (77°F)	2.45	2.40~2.50	0.1PA
Standby	25°C (77°F)	2.275	2.25~2.30	

Discharge Current VS. Discharge Voltage

Final Discharge Voltage V/Cell	1.75	1.70	1.60	1.30
Discharge Power(W)	0.1P>(W)	0.1P≤(W)<0.25P	0.25P≤(W)<1.0P	(W)≥1.0P

Sales Office URL: WWW.CSB-BATTERY.COM

CSB BATTERY CO., LTD.
TAIWAN OFFICE
Tel: +886-2-2555-5600
Fax: +886-2-2555-3300
E-mail: service@csb-battery.com.tw

CSB BATTERY LOGISTICS (SHANGHAI) CO., LTD.
SHANGHAI OFFICE
Tel: +86-21-5046-1622, 5046-0833
Fax: +86-21-5064-3314
E-mail: chinasls@csb-battery.com

CSB BATTERY TECHNOLOGIES, INC
USA OFFICE
Tel: +1-817-244-7777/1-8003 CSBUSA(272872)
Fax: +1-817-244-4445
E-mail: csb@csb-battery.com

CSB BATTERY LOGISTICS (SHANGHAI) CO., LTD.
BEIJING OFFICE
Tel: +86-10-6597-8060, 6597-8070
Fax: +86-10-6597-8050
E-mail: chinasls@csb-battery.com

CSB BATTERY OF NETHERLANDS B.V
NETHERLANDS OFFICE
Tel: +31(0) 180 418 140
Fax: +31(0) 180 418 327
E-mail: eurosales@csb-battery.com

CSB BATTERY LOGISTICS (SHANGHAI) CO., LTD.
SHENZHEN OFFICE
Tel: +86-755-8831-6488/6396/16356
Fax: +86-755-8831-6548
E-mail: she@csb-battery.com.cn